

# 2022 4Q Investors' Conference

Mr. Wen Chen  
April 10, 2023

# Agenda

1. Company Profile
2. Products Introduction
3. State of Operation
4. Development

# Company Profile

- Founded: July 9, 2010 (TBI MOTION)
- Location: No.123, Sanduo Rd., Shulin Dist., New Taipei City 238, Taiwan
- Chairman: Mr. Ching-Kun Lee
- CEO: Mr. Ching-Sheng Lee
- Capital: NT\$ 942 million
- Numbers of Employee: 1,279 (As of March 31, 2023)
- Major Products: Ball Screw, Linear Guide, Ball Spline, and Single Axis Actuator
- Major Application Industries: Automation Industry, Robot Industry, Semi-conductor Industry, General Industrial Machinery, Medical Equipment, Solar Energy Equipment, Machine Tool, Parking System, etc.



# Products Introduction

# Transmission Technology 4.0 Best Choice



Ball Screw



Linear Guide

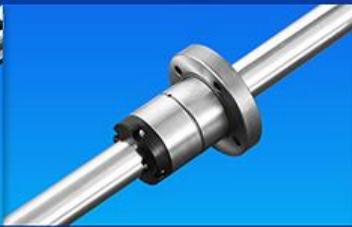

Ball Spline



Rotary Series

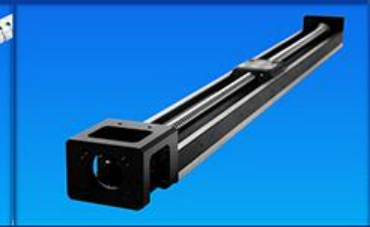

Single Axis Actuator

Linear component is the heart of the machine.  
Machine can easily run with high accuracy performance through steel balls endless rotation.

## Application

- Automation Industry
- Semi-conductor Industry
- Robot Industry
- Medical Equipment
- Solar Energy Equipment
- Machine Tool
- Parking System
- Others

# Ball Screw (Complete Product Range)

Ball Screw	Rolled	Ground
Diameter	06~80mm	04~160mm
Lead	01~100mm	01~100mm
Accuracy	FC5~FC10	GC1~GC7
Strong Point	Core Technology in TBI	Customization Flexibility



# Linear Guide

International  
Standard TR -V



International  
Standard TR -F



TR-Self-Lubricating



TM-Miniature



Model	Dimension (mm)
Standard	15、20、25、30、35、45
Large	55、65
Miniature	07、09、12

Feature
Smooth Movement/High Stability
High Durability
Easy Installation with Interchangeability
Enhanced Dust-proof
J-flow System Self-Lubricating Linear Guide Series



# Ball Spline

(First Manufacturer in Taiwan)

SLF

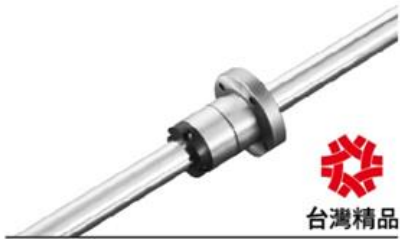

SLT



SOF



SOT



**Dimension**

**06~50mm**

**Feature**

- Hollow Spline Shaft
- Easy Mount on Design
- High Rigidity/ High Load-Carrying Capacity
- Zero Angular Clearance/ Backlash

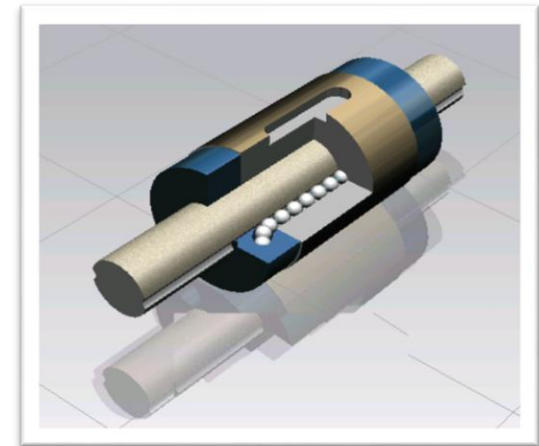

# Rotary Series Ball Screw / Spline

(First Manufacturer in Taiwan)

<b>Dimension</b>	<b>16~50mm</b>
<b>Feature</b>	<ul style="list-style-type: none"><li>•No backlash, High Position Accuracy</li><li>•High Rigidity/ High Speed</li><li>•Easy Assembling/ Space-Saving</li><li>• Both rotary and spiral movement achieve simultaneously</li></ul>



# Single Axis Actuator

<b>Dimension</b>	26、33、46
<b>Feature</b>	<ul style="list-style-type: none"><li>•Modularization</li><li>•Allows the X-axis and Y-axis to bear loads from all directions.</li><li>•High Rigidity: U-Rail track optimized section</li><li>•High Accuracy</li></ul>



# State of Operation

# Revenue

unit : NT\$ million

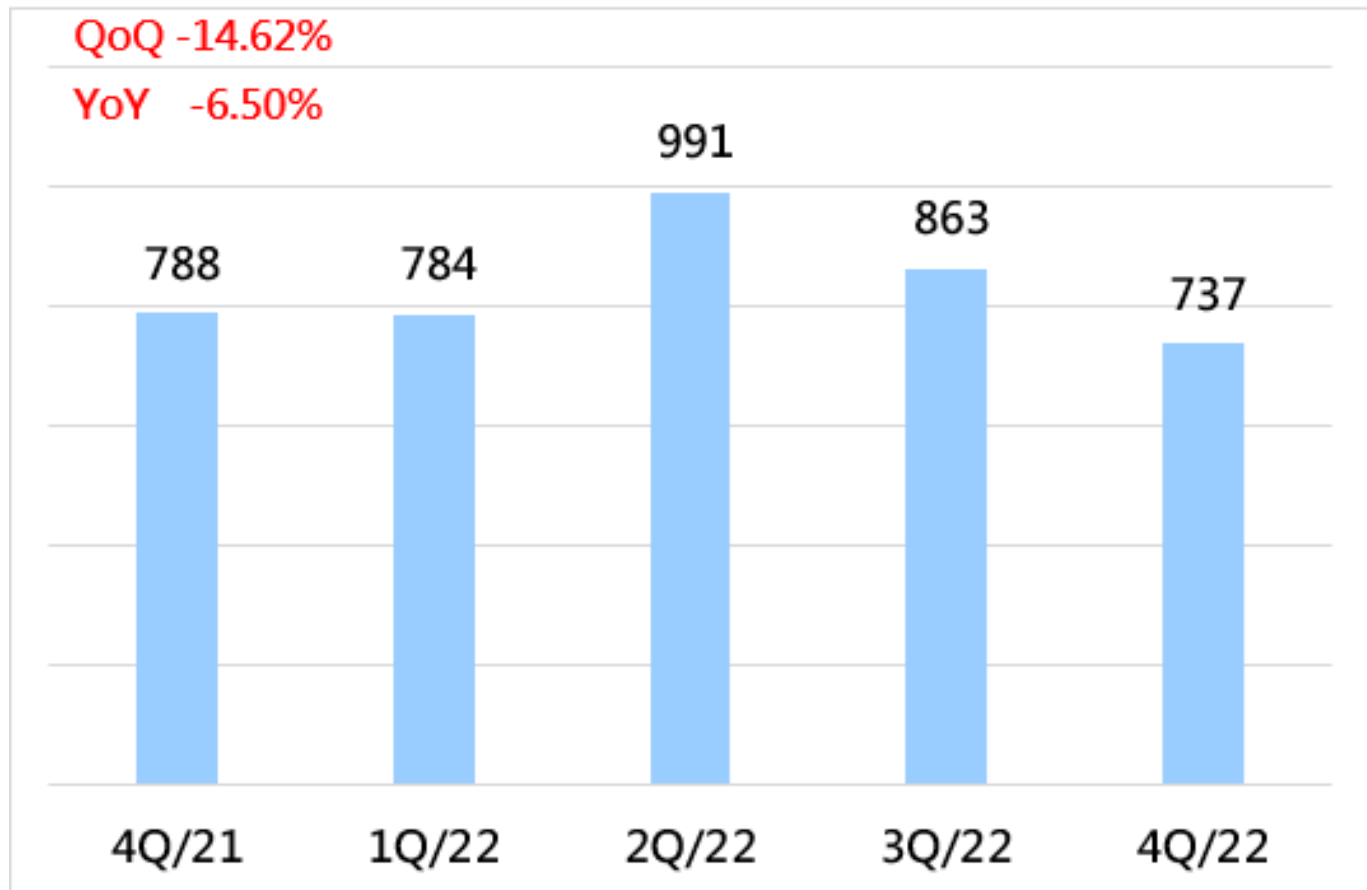

Data Source: Financial report by CPA audit or review.

# Revenue by Regions

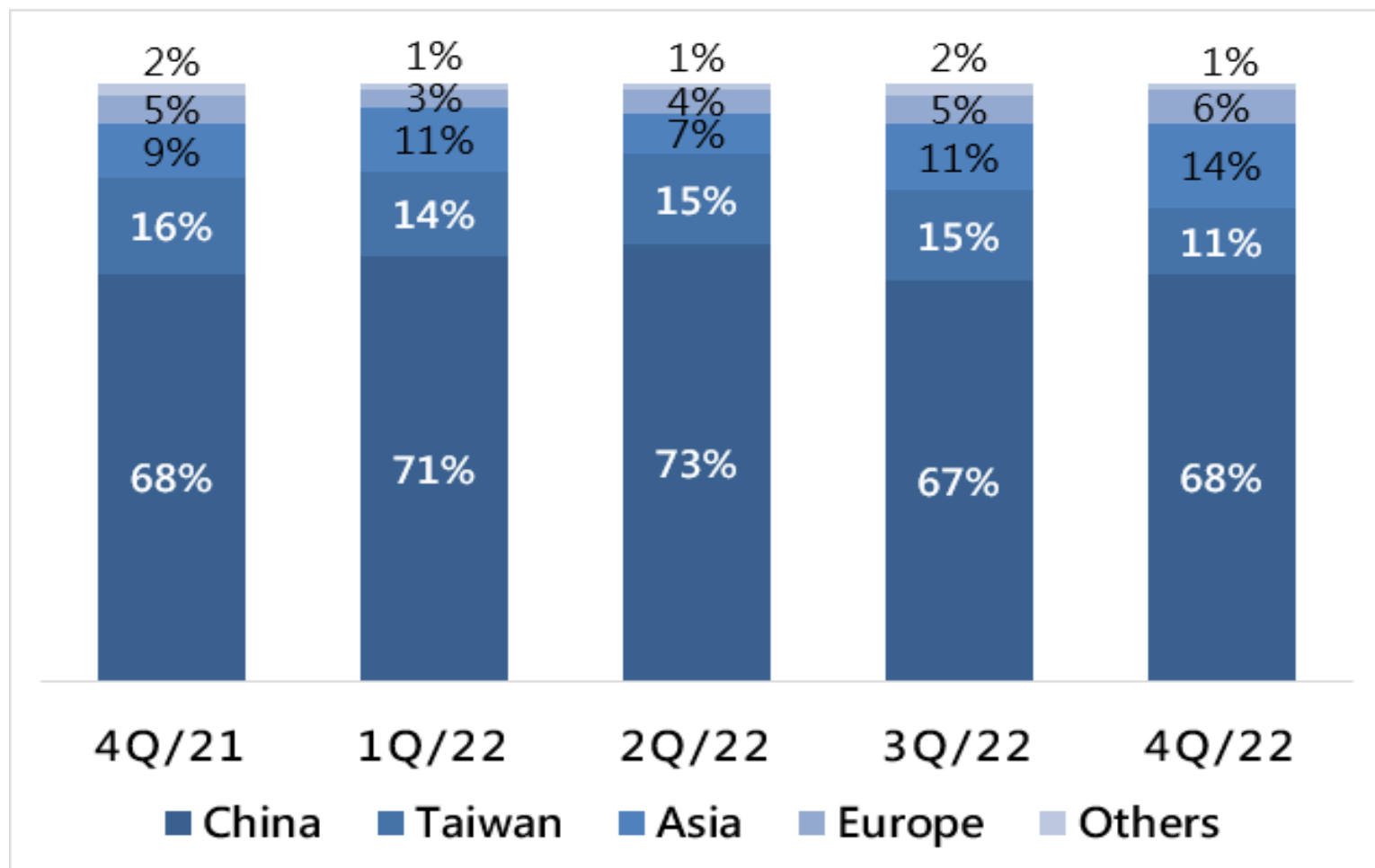

# Revenue by Products

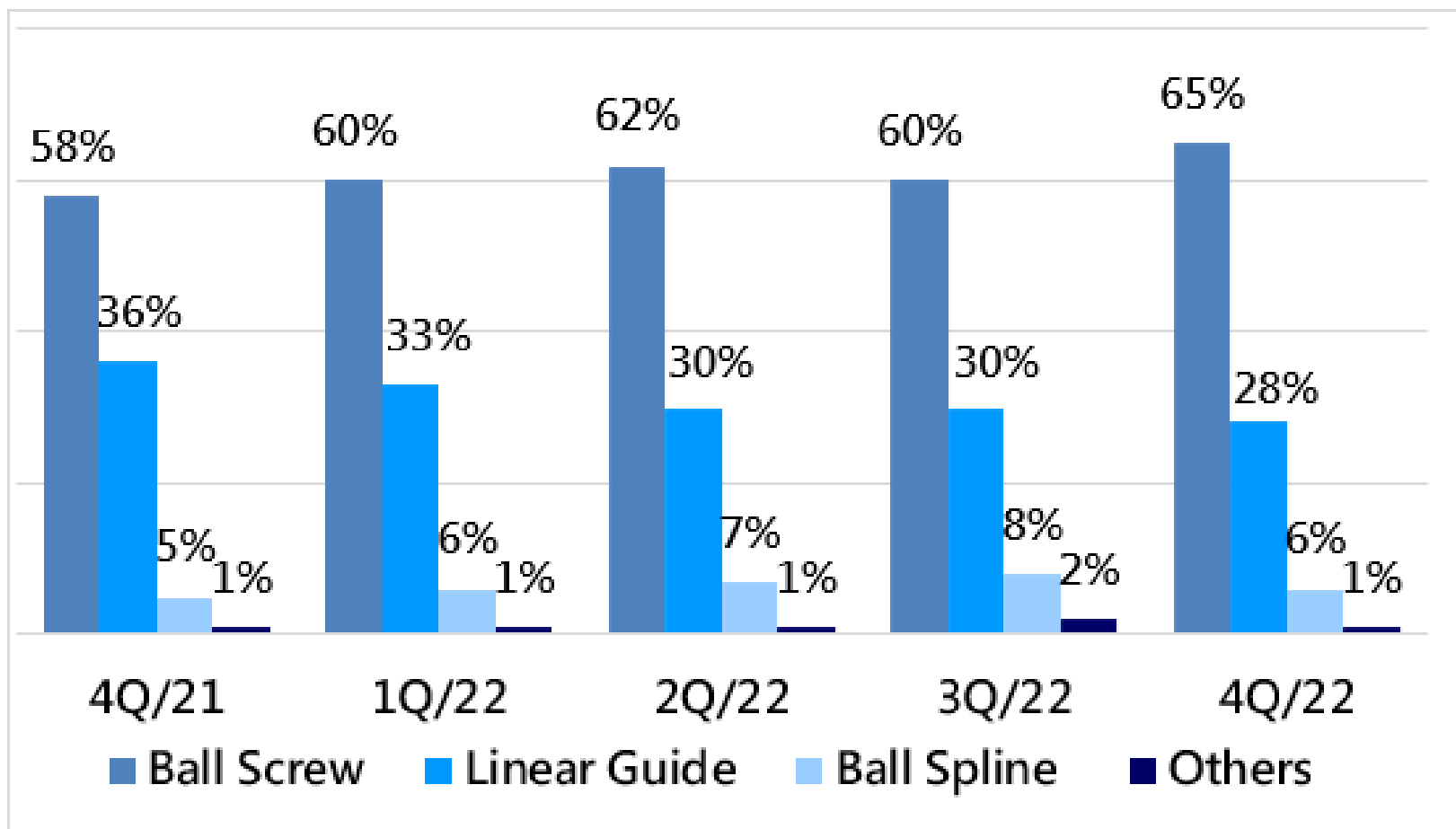

# Gross Profit

unit : NT\$ million ; %

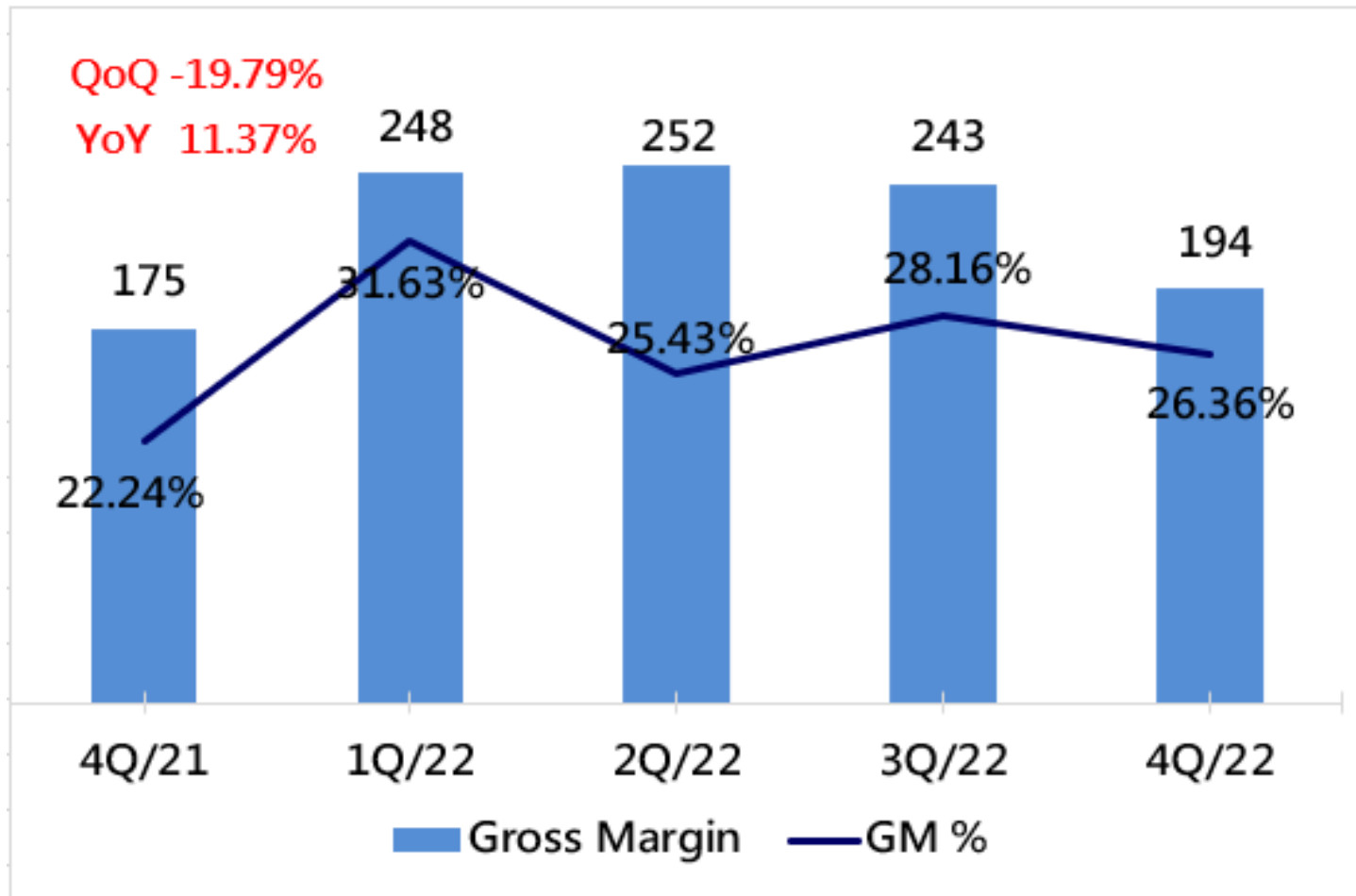



# Operating Profit

unit : NT\$ million ; %

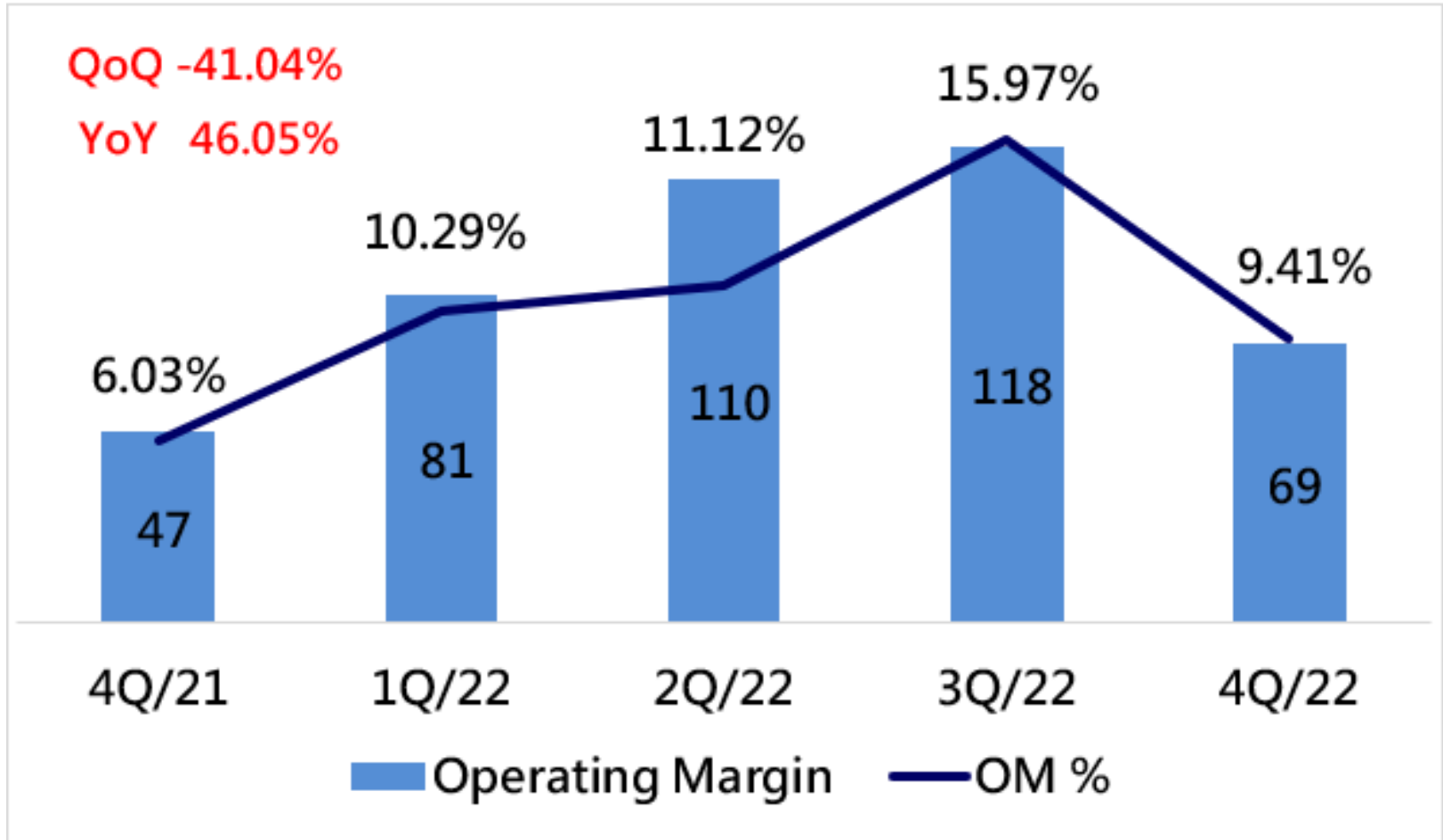

# Non-Operating Income and Expense

unit : NT\$ million

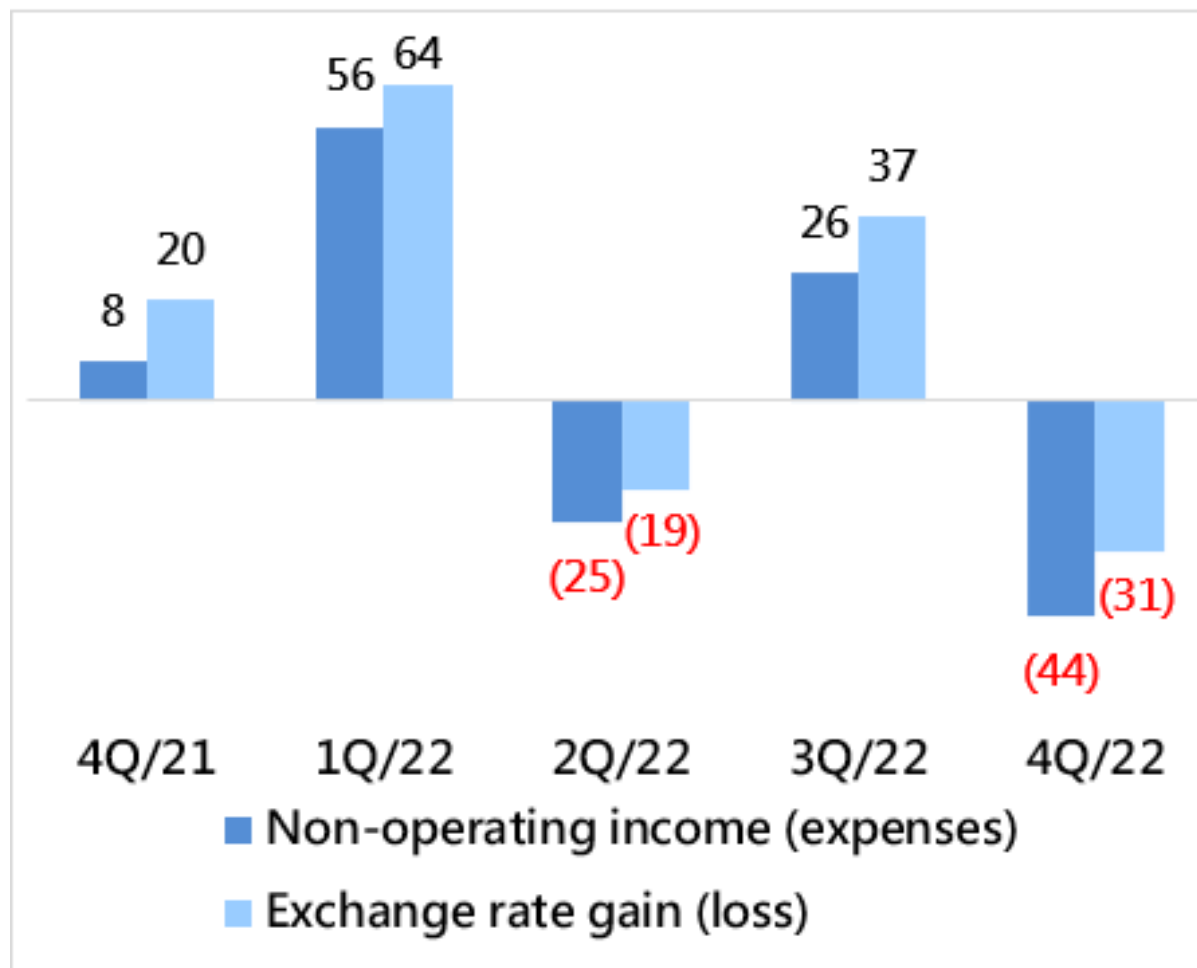

# Profit before Income Taxes Net Profits after Taxes

unit : NT\$ million ; %

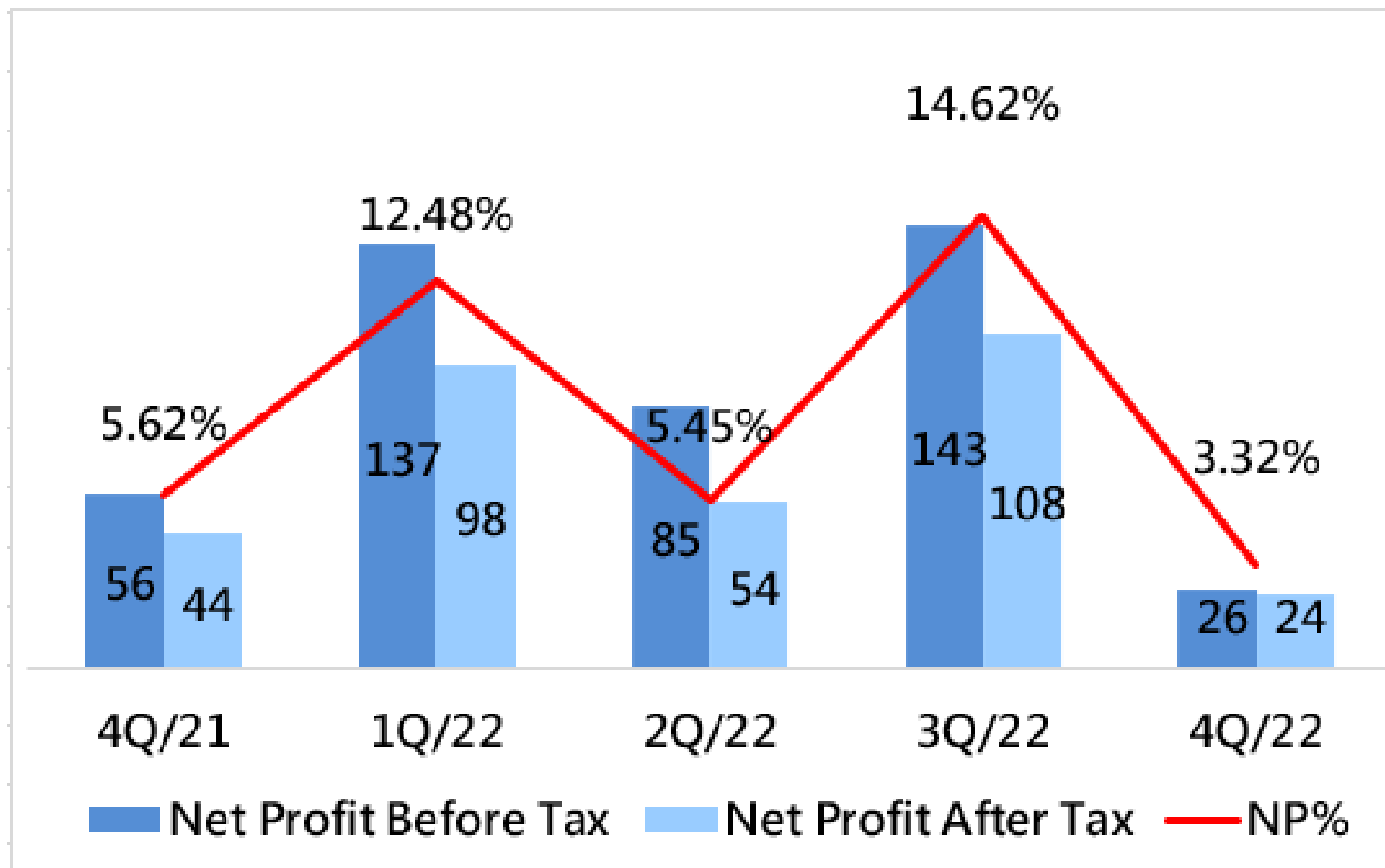

# EPS

Unit : NT\$

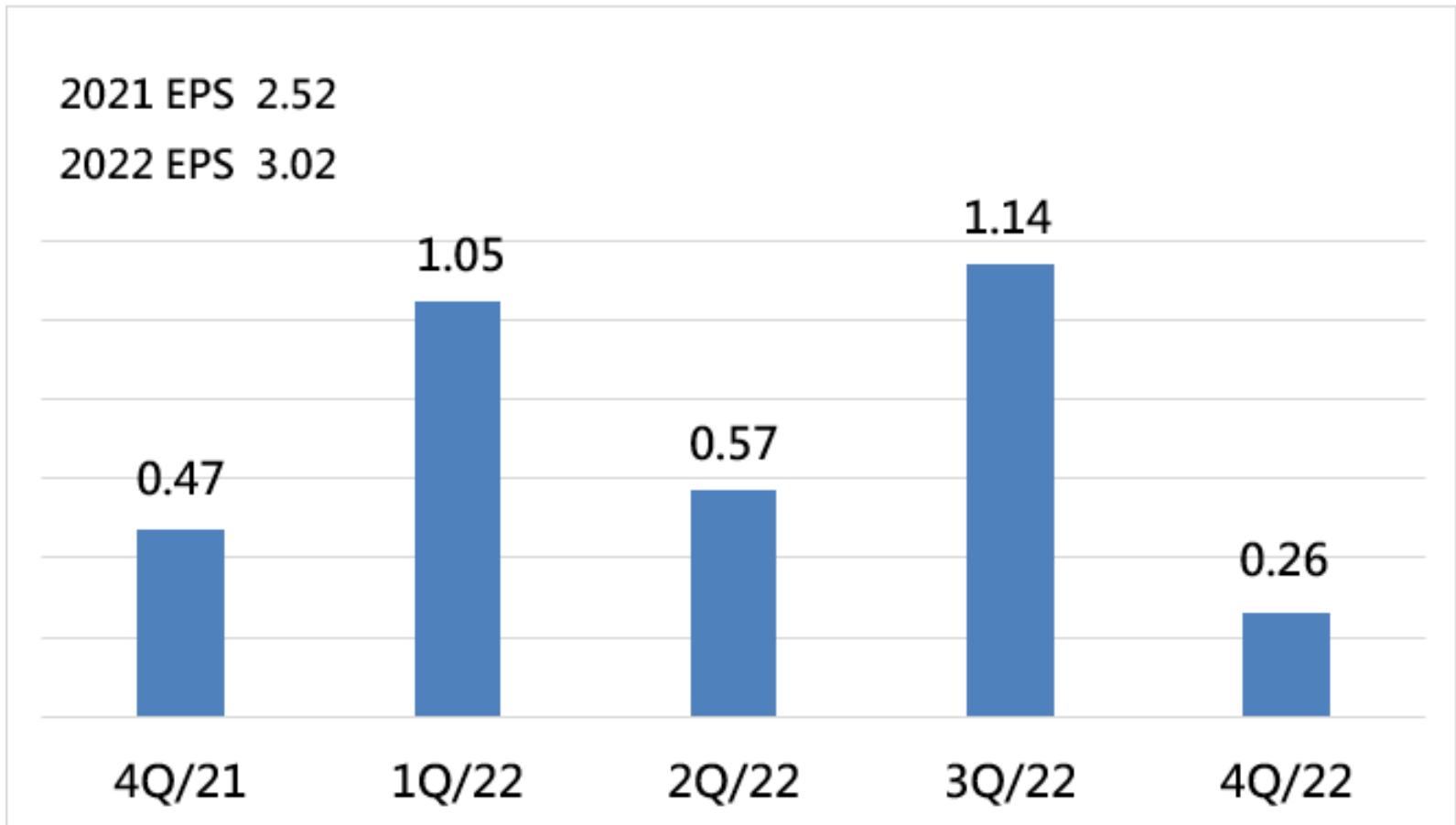

# Development

## Complete product series

- Roller guide
- Cross roller
- Ball nut for machine tool industry
- Caged linear guide
- Low noise feature
- Miniature ball screw

## Upgraded Product

- Automatic production
- Assembly process acceleration
- Higher production efficiency
- Cost Reduction and profit improvement

## R & D Service

- Customization
- Intelligentization application

# FUTURE IN MOTION



股票代碼：4540

THANK YOU FOR  
LISTENING!

